

McLED[®]

LED für Profis

• DEKORATIVE LEUCHTEN

• GARTENLEUCHTEN

• POLLERLEUCHTEN

• WANDLEUCHTEN

• DECKENLEUCHTEN

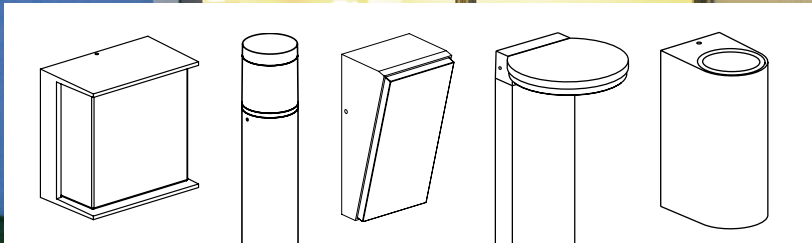

LED

Architektonische Aussenbeleuchtung

Preise 06 / 2020

DECKENLEUCHTEN

Name	Seite
Andromede R	3
Andromede S	
Noel R	4
Noel S	

WANDLEUCHTEN

Cygnus	5
Kerberos	
Draco R	6
Draco S	
Ursa R	7
Ursa S	
Corona V	8
Corona H	
Ether	9
Leon	
Kronos	10
Penelope	
Revos R	11
Revos 2R	
Revos S	
Revos 2S	
Verona R	12
Verona 2R	
Verona S	
Verona 2S	

GARTENLEUCHTEN

Framus W	13
Framus P	
Thea	14
Rhea	
Borg	15
Kira	

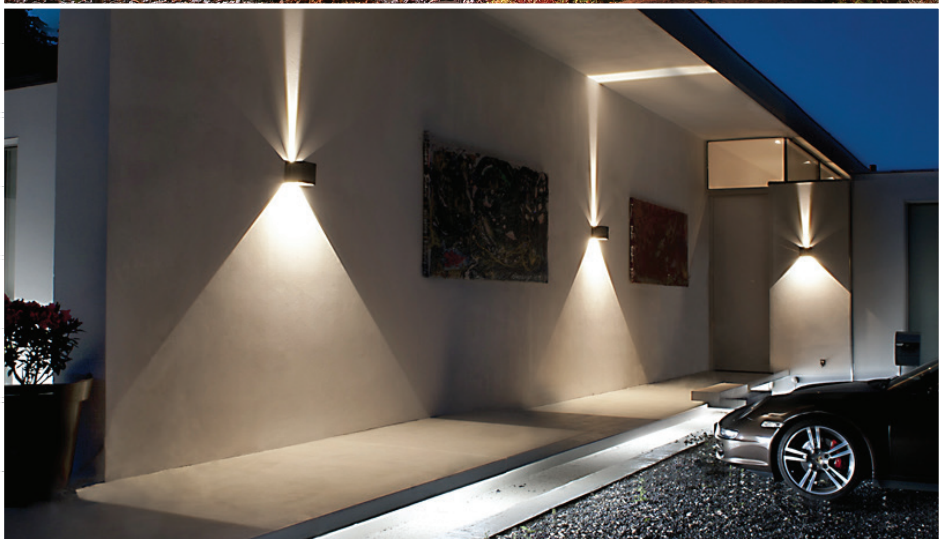

Andromede R

14 W 220-240 V IP 65 CRI >80 max +60°C min -20°C 30.000 Std. L70



Hochwertige Chips:



Hochwertiger Treiber:

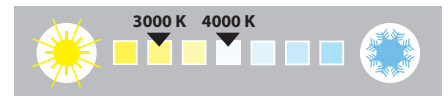
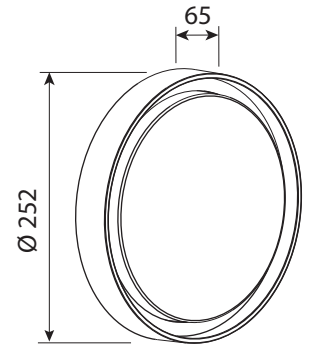

A+

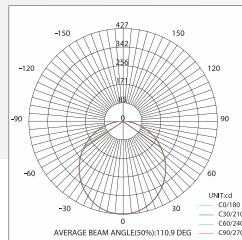
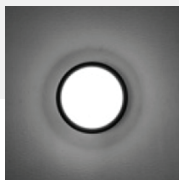

Farbe	Artikelnummer	Typ	Watt	Abstrahlwinkel	Lichtstrom	Farbtemperatur	PF	IP	Listenpreis*
schwarz	ML-516.005.19.0	AND-R-14W3000K-B	14 W	110°	1035 lm	3000 K	≥0,5	65	95,00 €
	ML-516.006.19.0	AND-R-14W4000K-B			1115 lm	4000 K			

- Aluminium Gehäuse
- Kunststoff Diffusor

*Listenpreise sind exklusiv Mehrwertsteuer. Andere Farbvarianten (weiß, grau) sind ab 30 Stück lieferbar.

IP65 CE

Andromede S

14 W 220-240 V IP 65 CRI >80 max +60°C min -20°C 30.000 Std. L70



Hochwertige Chips:



Hochwertiger Treiber:

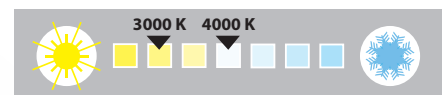
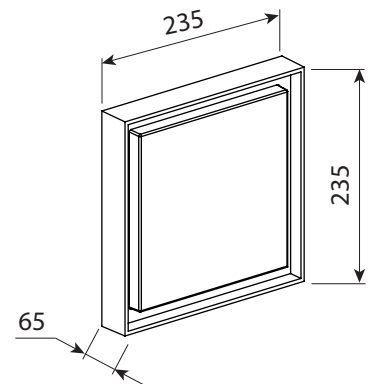

A+

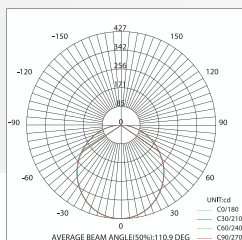
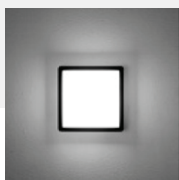

Farbe	Artikelnummer	Typ	Watt	Abstrahlwinkel	Lichtstrom	Farbtemperatur	PF	IP	Listenpreis*
schwarz	ML-516.007.19.0	AND-S-14W3000K-B	14 W	110°	1060 lm	3000 K	≥0,5	65	99,30 €
	ML-516.008.19.0	AND-S-14W4000K-B			1140 lm	4000 K			

- Aluminium Gehäuse
- Kunststoff Diffusor

*Listenpreise sind exklusiv Mehrwertsteuer. Andere Farbvarianten (weiß, grau) sind ab 30 Stück lieferbar.

IP65 CE

Noel R

Hochwertige Chips:



Hochwertiger Treiber:



7 W 220-240 V IP 65 CRI >80 max +60°C min -20°C 30.000 Std. L70

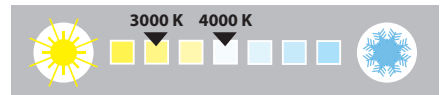
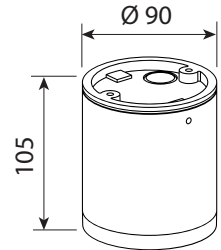

A+

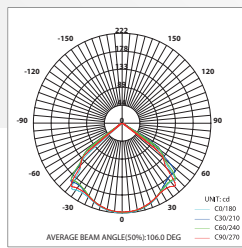

Farbe	Artikelnummer	Typ	Watt	Abstrahlwinkel	Lichtsrom	Farbtemperatur	PF	IP	Listenpreis*
schwarz	ML-516.011.19.0	NOE-R-7W3000K-B	7 W	102°	460 lm	3000 K	≥0,5	65	43,90 €
	ML-516.012.19.0	NOE-R-7W4000K-B			495 lm	4000 K			

- Aluminium Gehäuse
- Glas Diffusor

*Listenpreise sind exklusiv Mehrwertsteuer. Andere Farbvarianten (weiß, grau) sind ab 30 Stück lieferbar.



Noel S

Hochwertige Chips:



Hochwertiger Treiber:



7 W 220-240 V IP 65 CRI >80 max +60°C min -20°C 30.000 Std. L70

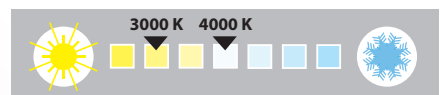
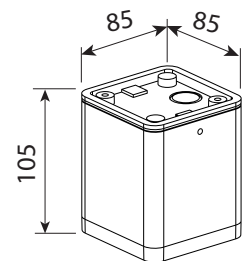

A+

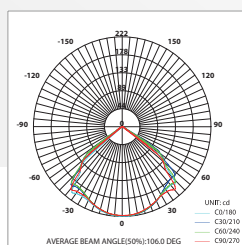
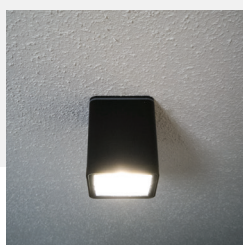

Farbe	Artikelnummer	Typ	Watt	Abstrahlwinkel	Lichtsrom	Farbtemperatur	PF	IP	Listenpreis*
schwarz	ML-516.009.19.0	NOE-S-7W3000K-B	7 W	102°	550 lm	3000 K	≥0,5	65	43,90 €
	ML-516.010.19.0	NOE-S-7W4000K-B			590 lm	4000 K			

- Aluminium Gehäuse
- Glas Diffusor

*Listenpreise sind exklusiv Mehrwertsteuer. Andere Farbvarianten (weiß, grau) sind ab 30 Stück lieferbar.



Cygnus

Hochwertige Chips:
 San'an

Hochwertiger Treiber:
 EDE POWER

8 W 220-240 V IP 65 CRI >80 max +60°C min -20°C 30000 Std. L70

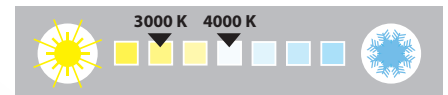
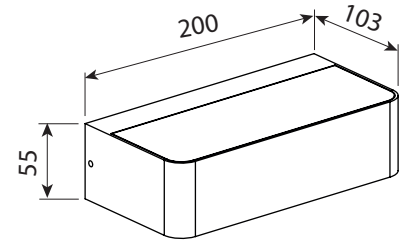

A+

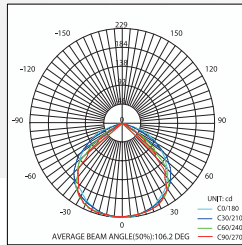

Farbe	Artikelnummer	Typ	Watt	Abstrahlwinkel	Lichtstrom	Farbtemperatur	PF	IP	Listenpreis*
schwarz	ML-518.001.19.0	CYG-8W3000K-B	8 W	105°	415 lm	3000 K	≥0,5	65	61,10 €
	ML-518.002.19.0	CYG-8W4000K-B			445 lm	4000 K			

- Aluminium Gehäuse
- Glas Diffusor

*Listenpreise sind exklusiv Mehrwertsteuer. Andere Farbvarianten (weiß, grau) sind ab 30 Stück lieferbar.

IP65 CE

Kerberos

Hochwertige Chips:
 San'an

Hochwertiger Treiber:
 EDE POWER

9 W 220-240 V IP 65 CRI >80 max +60°C min -20°C 30000 Std. L70

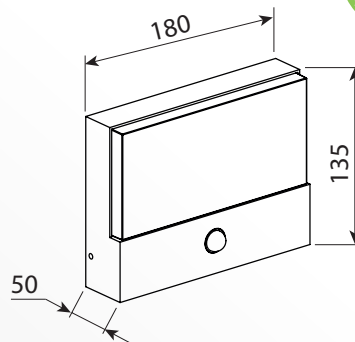

- Mit Bewegungssensor und Tageslichtsensor

Uebel detekce: 120° detection angle, 8m range.

Možnosti nastaveni: vypnuto, min 2 luxy, max 50 luxy; min 5 sekund, max 15 minut.



A+

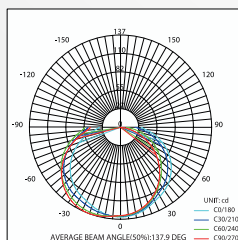
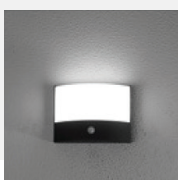

Farbe	Artikelnummer	Typ	Watt	Abstrahlwinkel	Lichtstrom	Farbtemperatur	PF	IP	Listenpreis*
schwarz	ML-513.024.19.0	KER-9W3000K-B	9 W	90°	600 lm	3000 K	≥0,5	65	65,40 €
	ML-513.025.19.0	KER-9W4000K-B			645 lm	4000 K			

- Aluminium Gehäuse
- Kunststoff Diffusor

*Listenpreise sind exklusiv Mehrwertsteuer. Andere Farbvarianten (weiß, grau) sind ab 30 Stück lieferbar.

IP65 CE

Draco R

Hochwertige Chips:



Hochwertiger Treiber:



9 W
220-240 V
IP 65
CRI >80
max +60°C
min -20°C
30000 Std. L70

• Die Leuchte enthält eine austauschbare Abdeckung von 145 mm oder 95 mm

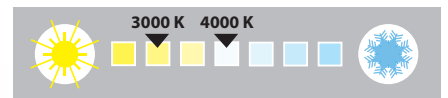
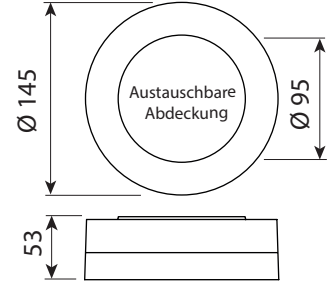

• In Verpackung sind beide vordere Abdeckungen geliefert.

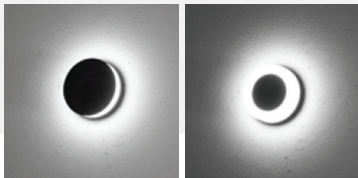

• Abdeckung Ø 145 mm
• Abdeckung Ø 95 mm

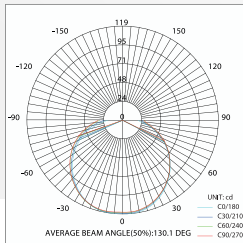

IP65 CE

Farbe	Artikelnummer	Typ	Watt	Abstrahlwinkel	Lichtstrom	Farbtemperatur	PF	IP	Listenpreis*
schwarz	ML-513.016.19.0	DRA-R-9W3000K-B	9 W	50° / 125°	230 lm / 470 lm	3000 K	≥0,5	65	54,20 €
	ML-513.017.19.0	DRA-R-9W4000K-B			250 lm / 505 lm	4000 K			

• Aluminium Gehäuse
• Kunststoff Diffusor

*Listenpreise sind exklusiv Mehrwertsteuer. Andere Farbvarianten (weiß, grau) sind ab 30 Stück lieferbar.

Draco S

Hochwertige Chips:



Hochwertiger Treiber:



9 W
220-240 V
IP 65
CRI >80
max +60°C
min -20°C
30000 Std. L70

• Die Leuchte enthält eine austauschbare Abdeckung von 135 x 135 mm oder 86 x 86 mm

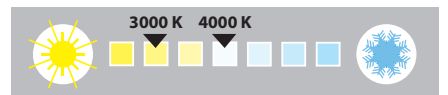
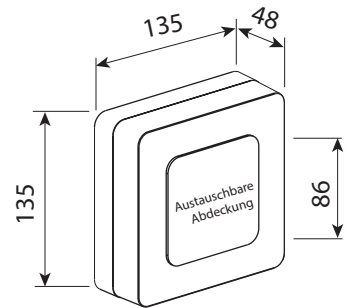

• In Verpackung sind beide vordere Abdeckungen geliefert.

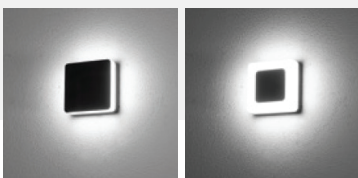

• Abdeckung 135 x 135 mm
• Abdeckung 86 x 86 mm

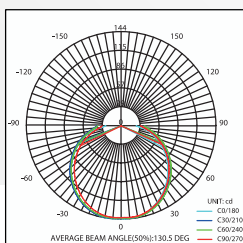

IP65 CE

Farbe	Artikelnummer	Typ	Watt	Abstrahlwinkel	Lichtstrom	Farbtemperatur	PF	IP	Listenpreis*
schwarz	ML-513.018.19.0	DRA-S-9W3000K-B	9 W	50° / 130°	270 lm / 560 lm	3000 K	≥0,5	65	58,10 €
	ML-513.019.19.0	DRA-S-9W4000K-B			290 lm / 605 lm	4000 K			

• Aluminium Gehäuse
• Kunststoff Diffusor

*Listenpreise sind exklusiv Mehrwertsteuer. Andere Farbvarianten (weiß, grau) sind ab 30 Stück lieferbar.

Ursa R

Hochwertige Chips:



Hochwertiger Treiber:



1,5 W	220-240 V	IP 65	CRI >80	max +60°C min -20°C	30.000 Std. L70	
--------------	------------------	--------------	-------------------	------------------------	-----------------	--

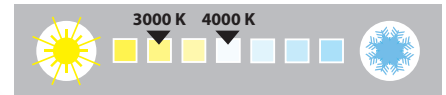
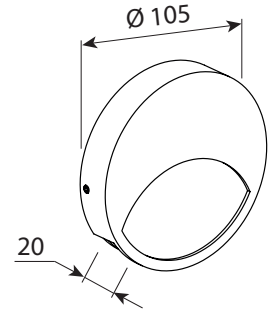

A+

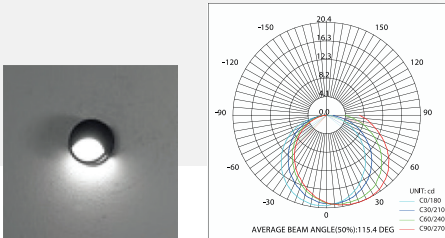

Farbe	Artikelnummer	Typ	Watt	Abstrahlwinkel	Lichtstrom	Farbtemperatur	PF	IP	Listenpreis*
schwarz	ML-517.003.19.0	URS-R-1,5W3000K-B	1,5 W	110°	60 lm	3000 K	≥0,5	65	30,10 €
	ML-517.004.19.0	URS-R-1,5W4000K-B			65 lm	4000 K			

- Aluminium Gehäuse
- Kunststoff Diffusor

*Listenpreise sind exklusiv Mehrwertsteuer.
 Andere Farbvarianten (weiß, grau) sind ab 30 Stück lieferbar.



Ursa S

Hochwertige Chips:



Hochwertiger Treiber:



1,5 W	220-240 V	IP 65	CRI >80	max +60°C min -20°C	30.000 Std. L70	
--------------	------------------	--------------	-------------------	------------------------	-----------------	--

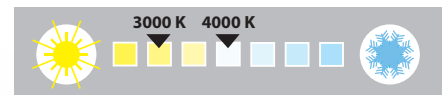
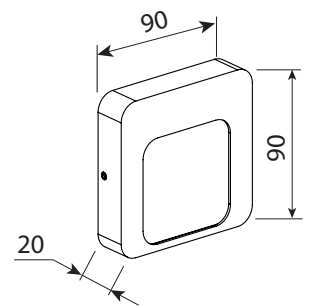
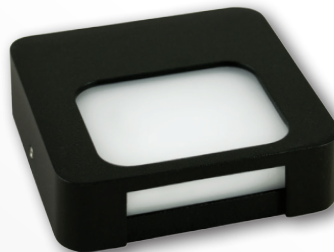

A+

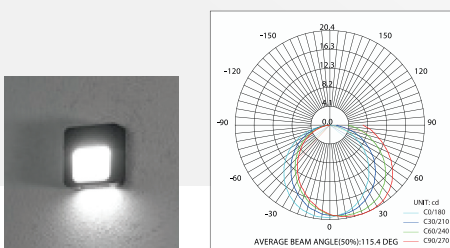

Farbe	Artikelnummer	Typ	Watt	Abstrahlwinkel	Lichtstrom	Farbtemperatur	PF	IP	Listenpreis*
schwarz	ML-517.005.19.0	URS-S-1,5W3000K-B	1,5 W	110°	60 lm	3000 K	≥0,5	65	30,10 €
	ML-517.006.19.0	URS-S-1,5W4000K-B			65 lm	4000 K			

- Aluminium Gehäuse
- Kunststoff Diffusor

*Listenpreise sind exklusiv Mehrwertsteuer.
 Andere Farbvarianten (weiß, grau) sind ab 30 Stück lieferbar.



Corona V

9 W
220-240 V
IP 65
CRI >80
max +60°C min -20°C
30 000 Std. L70

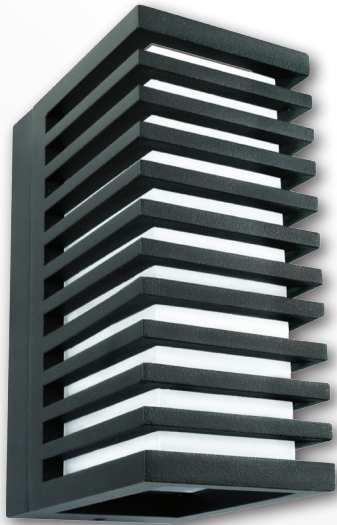

Hochwertige Chips:



Hochwertiger Treiber:

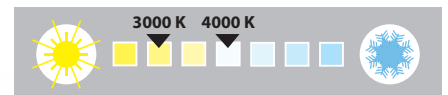
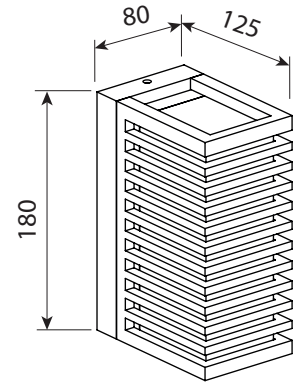

A+

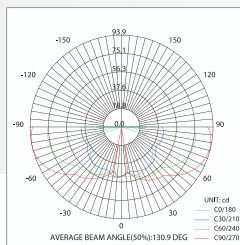

Farbe	Artikelnummer	Typ	Watt	Abstrahlwinkel	Lichtstrom	Farbtemperatur	PF	IP	Listenpreis*
schwarz	ML-513.020.19.0	COR-V-9W3000K-B	9 W	140 °	345 lm	3000 K	≥0,5	65	72,20 €
	ML-513.021.19.0	COR-V-9W4000K-B			375 lm	4000 K			

- Aluminium Gehäuse
- Kunststoff Diffusor

*Listenpreise sind exklusiv Mehrwertsteuer.
 Andere Farbvarianten (weiß, grau) sind ab 30 Stück lieferbar.

IP65 CE

Corona H

9 W
220-240 V
IP 65
CRI >80
max +60°C min -20°C
30 000 Std. L70



Hochwertige Chips:



Hochwertiger Treiber:

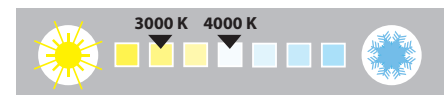
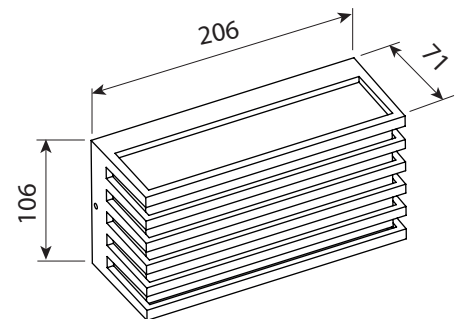

A+

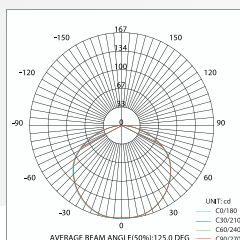
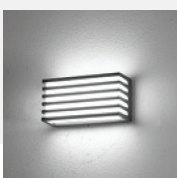

Farbe	Artikelnummer	Typ	Watt	Abstrahlwinkel	Lichtstrom	Farbtemperatur	PF	IP	Listenpreis*
schwarz	ML-513.022.19.0	COR-H-9W3000K-B	9 W	140 °	265 lm	3000 K	≥0,5	65	65,40 €
	ML-513.023.19.0	COR-H-9W4000K-B			285 lm	4000 K			

- Aluminium Gehäuse
- Kunststoff Diffusor

*Listenpreise sind exklusiv Mehrwertsteuer.
 Andere Farbvarianten (weiß, grau) sind ab 30 Stück lieferbar.

IP65 CE

Ether

9 W
220-240 V
IP 65
CRI >80
max +60°C min -20°C
30000 Std. L70



Hochwertige Chips:



Hochwertiger Treiber:

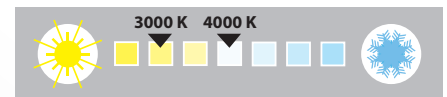
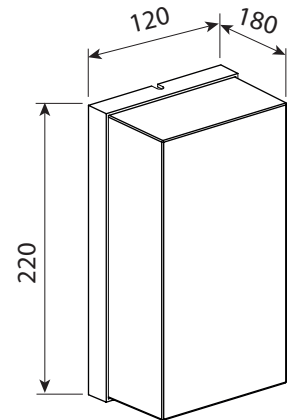

A+

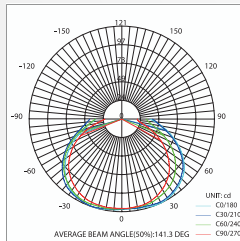

IP65 CE

Farbe	Artikelnummer	Typ	Watt	Abstrahlwinkel	Lichtstrom	Farbtemperatur	PF	IP	Listenpreis*
schwarz	ML-513.030.19.0	ETH-9W3000K-B	9 W	135 °	670 lm	3000 K	≥0,5	65	67,10 €
	ML-513.031.19.0	ETH-9W4000K-B			720 lm	4000 K			

- Aluminium Gehäuse
- Kunststoff Diffusor

*Listenpreise sind exklusiv Mehrwertsteuer. Andere Farbvarianten (weiß, grau) sind ab 30 Stück lieferbar.

Leon

9 W
220-240 V
IP 65
CRI >80
max +60°C min -20°C
30000 Std. L70



Hochwertige Chips:



Hochwertiger Treiber:

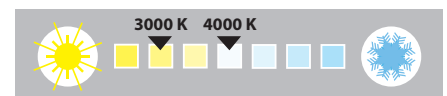
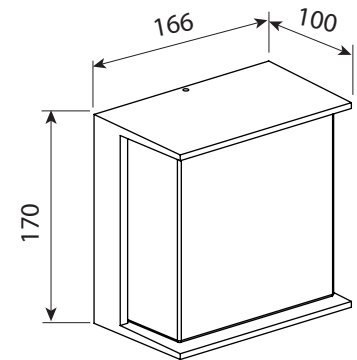

A+

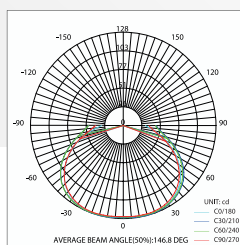

IP65 CE

Farbe	Artikelnummer	Typ	Watt	Abstrahlwinkel	Lichtstrom	Farbtemperatur	PF	IP	Listenpreis*
schwarz	ML-513.034.19.0	LEO-9W3000K-B	9 W	140 °	485 lm	3000 K	≥0,5	65	72,20 €
	ML-513.035.19.0	LEO-9W4000K-B			520 lm	4000 K			

- Aluminium Gehäuse
- Kunststoff Diffusor

*Listenpreise sind exklusiv Mehrwertsteuer. Andere Farbvarianten (weiß, grau) sind ab 30 Stück lieferbar.

Kronos

9 W
220-240 V
IP 65
CRI >80
max +60°C min -20°C
30000 Std. L70



Hochwertige Chips:
 San'an
 Hochwertiger Treiber:
 EDGE POWER

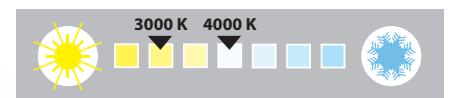
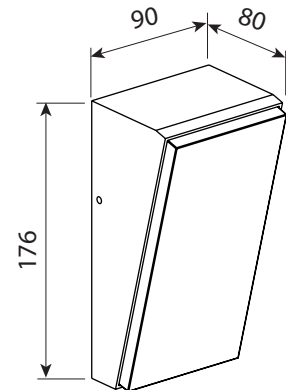

A+

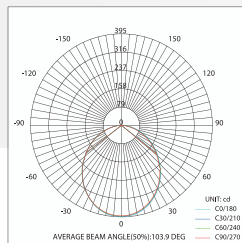

IP65 CE

Farbe	Artikelnummer	Typ	Watt	Abstrahlwinkel	Lichtsrom	Farbtemperatur	PF	IP	Listenpreis*
schwarz	ML-513.026.19.0	KRO-9W3000K-B	9 W	115°	660 lm	3000 K	≥0,5	65	54,20 €
	ML-513.027.19.0	KRO-9W4000K-B			710 lm	4000 K			

- Aluminium Gehäuse
- Kunststoff Diffuser

*Listenpreise sind exklusiv Mehrwertsteuer. Andere Farbvarianten (weiß, grau) sind ab 30 Stück lieferbar.

Penelope

9 W
220-240 V
IP 65
CRI >80
max +60°C min -20°C
30000 Std. L70



Hochwertige Chips:
 San'an
 Hochwertiger Treiber:
 EDGE POWER

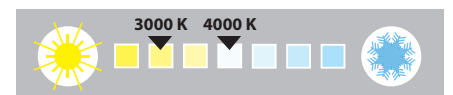
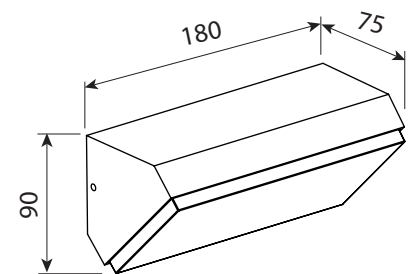

A+

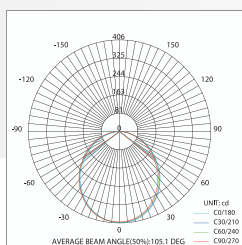
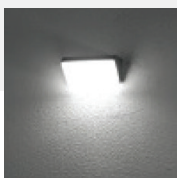

IP65 CE

Farbe	Artikelnummer	Typ	Watt	Abstrahlwinkel	Lichtsrom	Farbtemperatur	PF	IP	Listenpreis*
schwarz	ML-513.028.19.0	PEN-9W3000K-B	9 W	115°	635 lm	3000 K	≥0,5	65	54,20 €
	ML-513.029.19.0	PEN-9W4000K-B			685 lm	4000 K			

- Aluminium Gehäuse
- Kunststoff Diffuser

*Listenpreise sind exklusiv Mehrwertsteuer. Andere Farbvarianten (weiß, grau) sind ab 30 Stück lieferbar.

Revos 2R

3 W
6 W
220-240 V
IP 65
CRI >80
max +60°C min -20°C
30000 Std. L70

Revos R



Hochwertige Chips:



Hochwertiger Treiber:

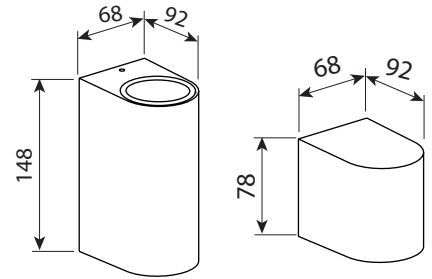

A+

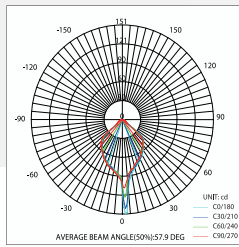

IP65 CE



Farbe	Artikelnummer	Typ	Watt	Abstrahlwinkel	Lichtstrom	Farbtemperatur	PF	IP	Listenpreis*
schwarz	ML-518.005.19.0	REV-R-3W3000K-B	3 W	37°	140 lm	3000 K	≥0,5	65	40,90 €
	ML-518.006.19.0	REV-R-3W4000K-B			150 lm	4000 K			
schwarz	ML-518.009.19.0	REV-2R-6W3000K-B	6 W	37°	290 lm	3000 K	≥0,5	65	49,90 €
	ML-518.010.19.0	REV-2R-6W4000K-B			310 lm	4000 K			

- Aluminium Gehäuse
- Glas Diffusor

*Listenpreise sind exklusiv Mehrwertsteuer. Andere Farbvarianten (weiß, grau) sind ab 30 Stück lieferbar.

Revos 2S

3 W
6 W
220-240 V
IP 65
CRI >80
max +60°C min -20°C
30000 Std. L70

Revos S



Hochwertige Chips:



Hochwertiger Treiber:

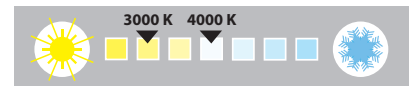
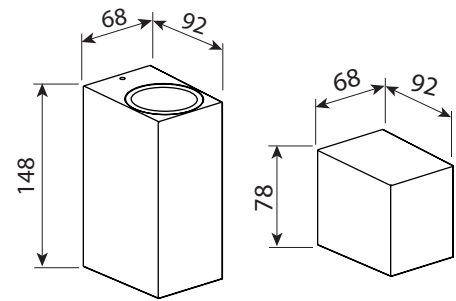

A+

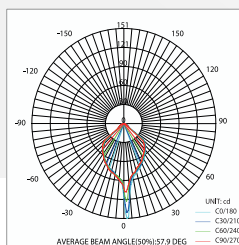

IP65 CE



Farbe	Artikelnummer	Typ	Watt	Abstrahlwinkel	Lichtstrom	Farbtemperatur	PF	IP	Listenpreis*
schwarz	ML-518.003.19.0	REV-S-3W3000K-B	3 W	37°	140 lm	3000 K	≥0,5	65	40,90 €
	ML-518.004.19.0	REV-S-3W4000K-B			150 lm	4000 K			
schwarz	ML-518.007.19.0	REV-2S-6W3000K-B	6 W	37°	290 lm	3000 K	≥0,5	65	49,90 €
	ML-518.008.19.0	REV-2S-6W4000K-B			310 lm	4000 K			

- Aluminium Gehäuse
- Glas Diffusor

*Listenpreise sind exklusiv Mehrwertsteuer. Andere Farbvarianten (weiß, grau) sind ab 30 Stück lieferbar.

Verona 2R

7 W 14 W 220-240 V IP 65 CRI >80 max +60°C min -20°C 30 000 Std. L70

Verona R



Hochwertige Chips: **CREE**
 Hochwertiger Treiber: **EDE POWER**

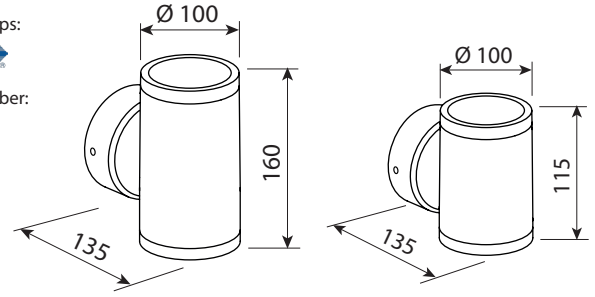

Farbe	Artikelnummer	Typ	Watt	Abstrahlwinkel	Lichtstrom	Farbtemperatur	PF	IP	Listenpreis*
schwarz	ML-518.013.19.0	VER-R-7W3000K-B	7 W	102°	460 lm	3000 K	≥0,5	65	Auf Anfrage
	ML-518.014.19.0	VER-R-7W4000K-B			495 lm	4000 K			
schwarz	ML-518.015.19.0	VER-2R-14W3000K-B	14 W	102°	890 lm	3000 K	≥0,5	65	Auf Anfrage
	ML-518.016.19.0	VER-2R-14W4000K-B			955 lm	4000 K			

- Aluminium Gehäuse
- Glas Diffusor

Andere Farbvarianten (weiß, grau) sind ab 30 Stück lieferbar.

A+

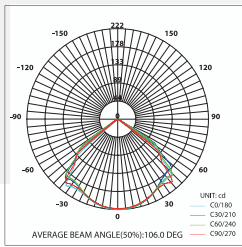

IP65 CE

Verona 2S

7 W 14 W 220-240 V IP 65 CRI >80 max +60°C min -20°C 30 000 Std. L70

Verona S



Hochwertige Chips: **CREE**
 Hochwertiger Treiber: **EDE POWER**

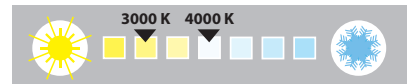
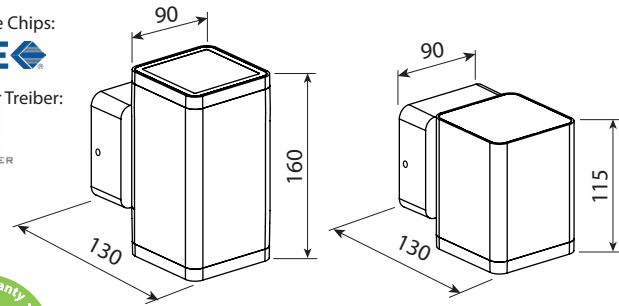

Farbe	Artikelnummer	Typ	Watt	Abstrahlwinkel	Lichtstrom	Farbtemperatur	PF	IP	Listenpreis*
schwarz	ML-518.017.19.0	VER-S-7W3000K-B	7 W	102°	460 lm	3000 K	≥0,5	65	Auf Anfrage
	ML-518.018.19.0	VER-S-7W4000K-B			495 lm	4000 K			
schwarz	ML-518.019.19.0	VER-2S-14W3000K-B	14 W	102°	890 lm	3000 K	≥0,5	65	Auf Anfrage
	ML-518.020.19.0	VER-2S-14W4000K-B			955 lm	4000 K			

- Aluminium Gehäuse
- Glas Diffusor

Andere Farbvarianten (weiß, grau) sind ab 30 Stück lieferbar.

A+

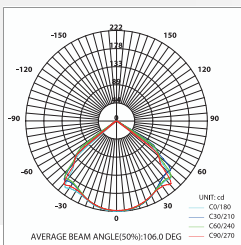

IP65 CE

Framus W

Hochwertige Chips:

 Hochwertiger Treiber:

9 W
220-240 V
IP 65
CRI >80
max +60°C min -20°C
30 000 Std. L70

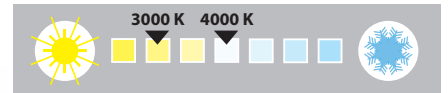
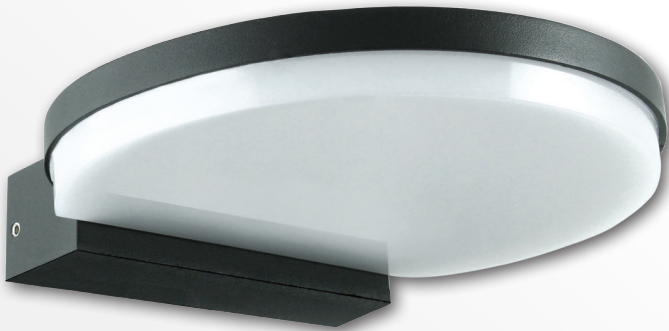
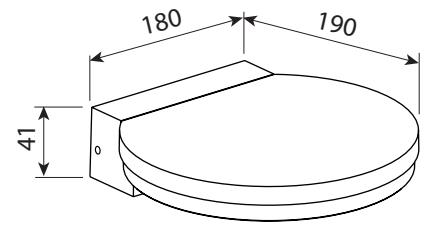
A+

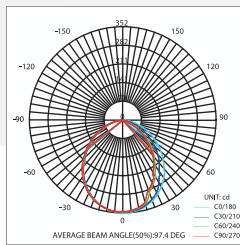

IP65 CE 

Farbe	Artikelnummer	Typ	Watt	Abstrahlwinkel	Lichtsrom	Farbtemperatur	PF	IP	Listenpreis*
schwarz	ML-513.032.19.0	FRA-W-9W3000K-B	9 W	115 °	590 lm	3000 K	≥0,5	65	54,20 €
	ML-513.033.19.0	FRA-W-9W4000K-B			635 lm	4000 K			

- Aluminium Gehäuse
- Kunststoff Diffusor

*Listenpreise sind exklusiv Mehrwertsteuer.
 Andere Farbvarianten (weiß, grau) sind ab 30 Stück lieferbar.

Framus P

Hochwertige Chips:

 Hochwertiger Treiber:

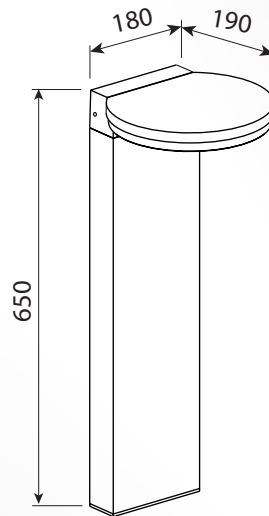
9 W
220-240 V
IP 65
CRI >80
max +60°C min -20°C
30 000 Std. L70

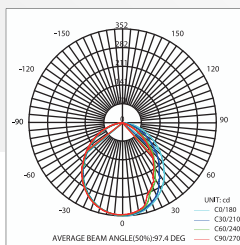
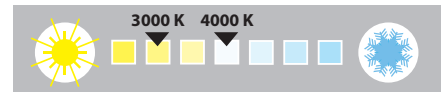

IP65 CE 

Farbe	Artikelnummer	Typ	Watt	Abstrahlwinkel	Lichtsrom	Farbtemperatur	PF	IP	Listenpreis*
schwarz	ML-515.011.19.0	FRA-P-9W3000K-B	9 W	115 °	590 lm	3000 K	≥0,5	65	81,30 €
	ML-515.012.19.0	FRA-P-9W4000K-B			635 lm	4000 K			

- Aluminium Gehäuse
- Kunststoff Diffusor

*Listenpreise sind exklusiv Mehrwertsteuer.
 Andere Farbvarianten (weiß, grau) sind ab 30 Stück lieferbar.

Thea



Hochwertige Chips:
 San'an
 Hochwertiger Treiber:
 EDE POWER



9 W **220-240 V** **IP 65**

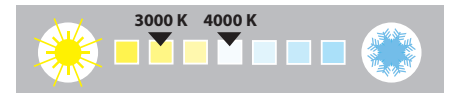

A+

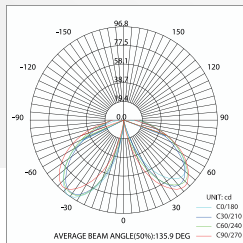

Farbe	Artikelnummer	Typ	Watt	Abstrahlwinkel	Lichtstrom	Farbtemperatur	PF	IP	Listenpreis*
schwarz	ML-515.007.19.0	THE-9W3000K-B	9 W	115°	375 lm	3000 K	≥0,5	65	77,40 €
	ML-515.008.19.0	THE-9W4000K-B			405 lm	4000 K			

- Aluminium Gehäuse
- Kunststoff Diffusor

*Listenpreise sind exklusiv Mehrwertsteuer.
 Andere Farbvarianten (weiß, grau) sind ab 30 Stück lieferbar.

IP65 CE

Rhea



Hochwertige Chips:
 CREE
 Hochwertiger Treiber:
 EDE POWER

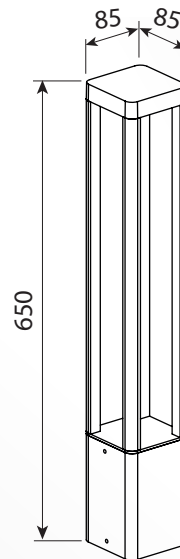

7 W **220-240 V** **IP 65**

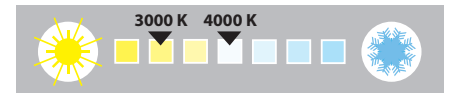

A+

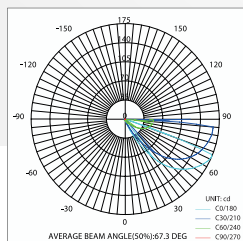

Farbe	Artikelnummer	Typ	Watt	Abstrahlwinkel	Lichtstrom	Farbtemperatur	PF	IP	Listenpreis*
schwarz	ML-515.009.19.0	RHE-7W3000K-B	7 W	15°	330 lm	3000 K	≥0,5	65	74,40 €
	ML-515.010.19.0	RHE-7W4000K-B			350 lm	4000 K			

- Aluminium Gehäuse
- Glas Diffusor

*Listenpreise sind exklusiv Mehrwertsteuer.
 Andere Farbvarianten (weiß, grau) sind ab 30 Stück lieferbar.

IP65 CE

Borg



Hochwertige Chips:
CREE
Hochwertiger Treiber:
EDE POWER

7 W 220-240 V IP 65 CRI >80 max +60°C min -20°C 30 000 Std. L70

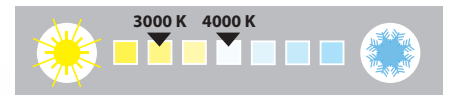
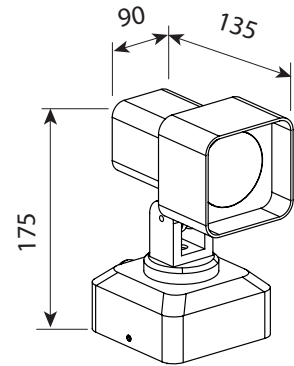

A+

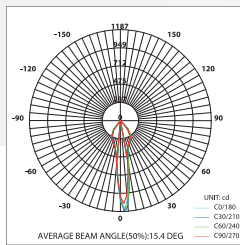

Farbe	Artikelnummer	Typ	Watt	Abstrahlwinkel	Lichtstrom	Farbtemperatur	PF	IP	Listenpreis*
schwarz	ML-514.001.19.0	BOR-7W4000K-B	7 W	15°	430 lm	3000 K	≥0,5	65	Auf Anfrage
	ML-514.002.19.0	BOR-7W4000K-B			465 lm	4000 K			

- Aluminium Gehäuse
- Glas Diffusor

Andere Farbvarianten (weiß, grau) sind ab 30 Stück lieferbar.

IP65 CE

Kira

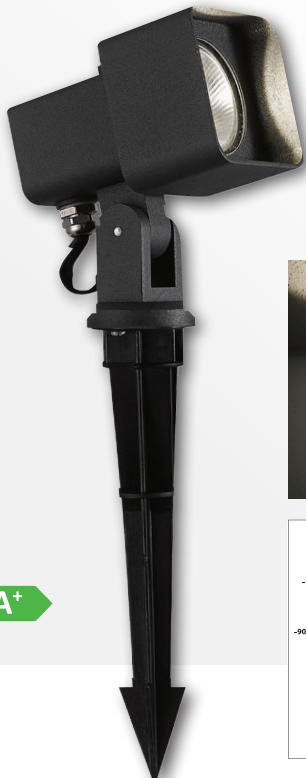

Hochwertige Chips:
CREE
Hochwertiger Treiber:
EDE POWER

7 W 220-240 V IP 65

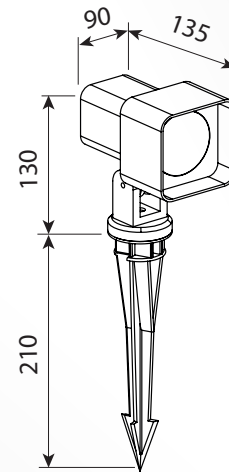
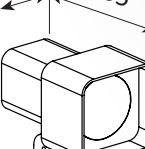

CRI >80 max +60°C min -20°C 30 000 Std. L70

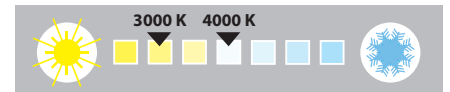

A+

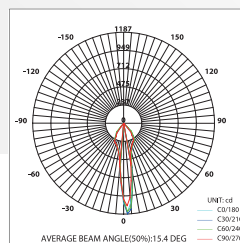

Farbe	Artikelnummer	Typ	Watt	Abstrahlwinkel	Lichtstrom	Farbtemperatur	PF	IP	Listenpreis*
schwarz	ML-514.003.19.0	KIR-7W3000K-B	7 W	15°	430 lm	3000 K	≥0,5	65	Auf Anfrage
	ML-514.004.19.0	KIR-7W4000K-B			465 lm	4000 K			

- Aluminium Gehäuse
- Glas Diffusor

Andere Farbvarianten (weiß, grau) sind ab 30 Stück lieferbar.

IP65 CE

 Schmachtl GmbH
Pummererstraße 36, A - 4020 Linz
Tel.: +43 732 7646 0; Fax: +43 732 785036
e-mail: office@mcled.at
www.mcled.at

www.mcled.at



Die Firma McLED GmbH behält sich das Recht auf technische Änderungen und Verbesserungen der McLED-Artikele vor.

• Technische Änderungen und Druckfehler vorbehalten • Die Fotos dienen nur zur Illustration

KAT-363.1_06/20_AT